

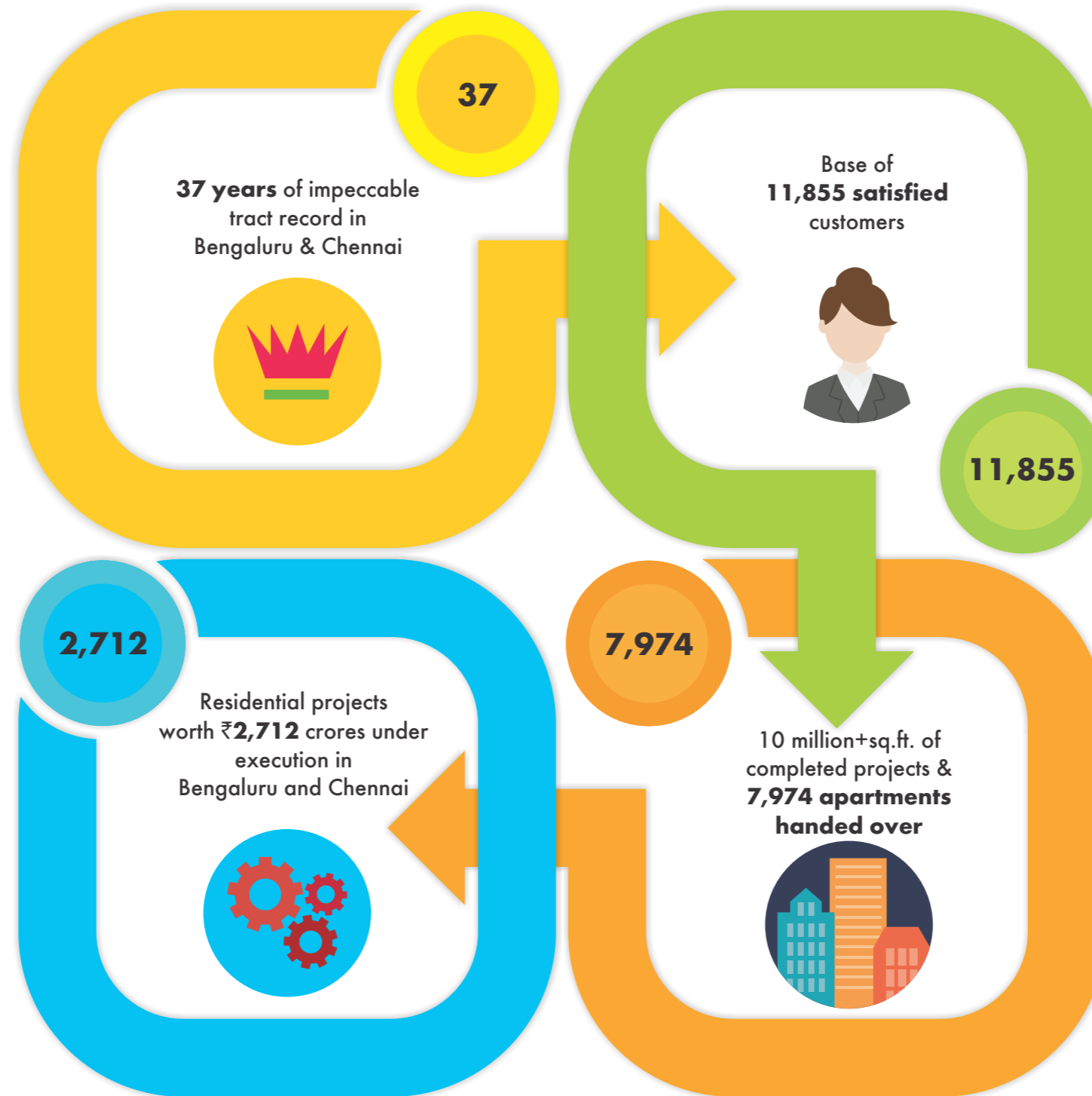



# ABOUT US



South India's First Developer to display Construction Timeline Meter at all project sites and to measure customer's happiness through Cisco's Customer Delight Meter.



# THE BOLDEST GUARANTEE IN THE HISTORY OF REAL ESTATE

---

WE ASSURE  
ON-TIME DELIVERY,  
OR WE PAY YOUR  
EMI TILL POSSESSION.





# ON TIME, EVERY TIME!



## OUR PAST COMMITMENTS

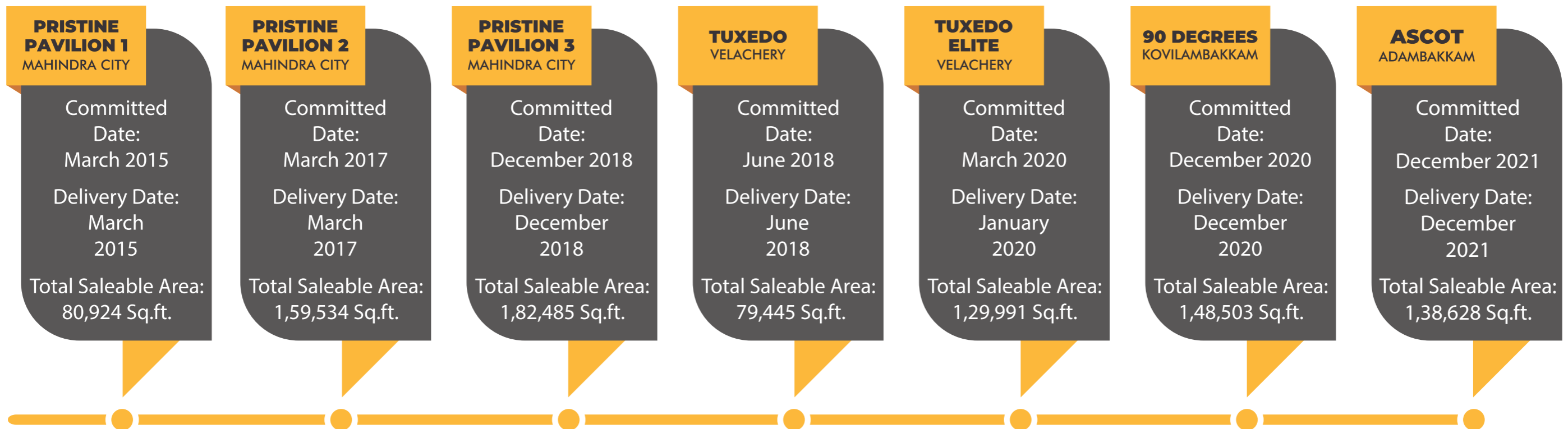

## OUR ONGOING COMMITMENTS

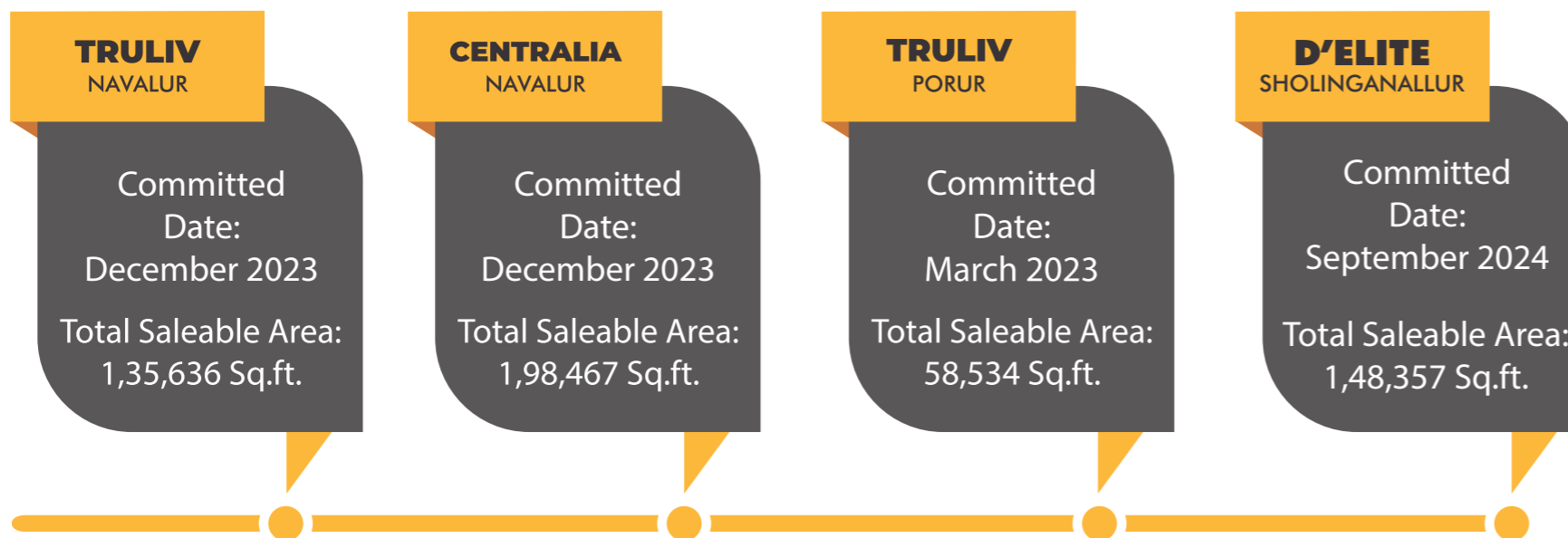



**CHENNAI'S FIRST DEVELOPER TO  
DISPLAY CONSTRUCTION TIMELINE METER  
AT ALL PROJECT SITES.**

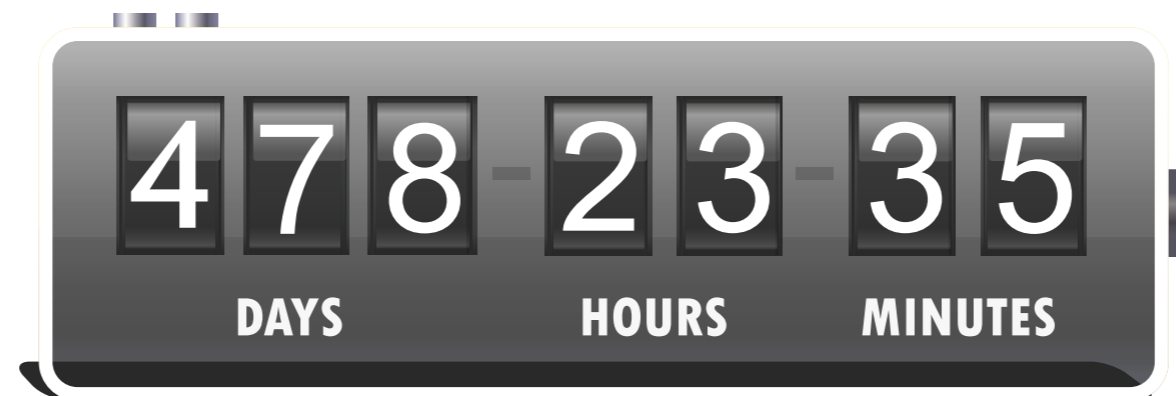

**CONSTRUCTION TIMELINE METER**



## CHENNAI'S FIRST DEVELOPER TO MEASURE CUSTOMERS' HAPPINESS THROUGH CUSTOMER DELIGHT METER





## WE CREATE PRUDENT INVESTMENTS THAT APPRECIATE WELL OVER TIME

DRA believes in creating value in our customers' lives by building home that reaps them a rich harvest in the future.

Customers who have invested with us have enjoyed multifold returns over the year & continue to do so even today. The choice you make shall be one based on premium service, proven track record & solid evidence of our expertise in giving our customers the finest value appreciation.

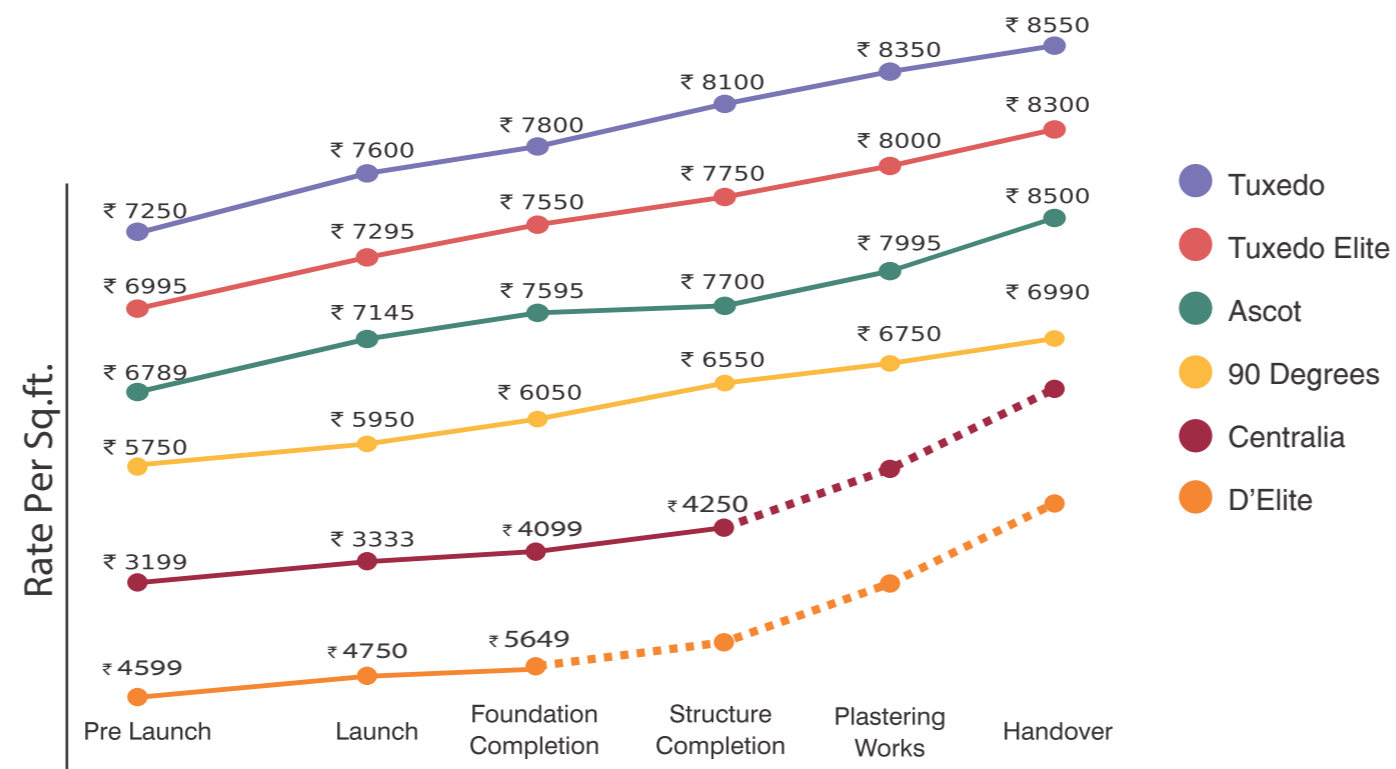

\* As on 1st Sep 2022



# FRONT ELEVATION - DAY VIEW





# FRONT ELEVATION - NIGHT VIEW





# AERIAL VIEW









# AMENITIES VIEWS

Aerobics & Zumba (Inside Club House)



Indoor Games (Inside Club House)





Gym (Inside Club House)



Multipurpose Hall (Inside Club House)





# AMENITIES VIEWS

Basket Ball Hoop



Badminton Court





Kids Play Area



Senior Citizen Area



Landscaped Garden





# LOCATION MAP

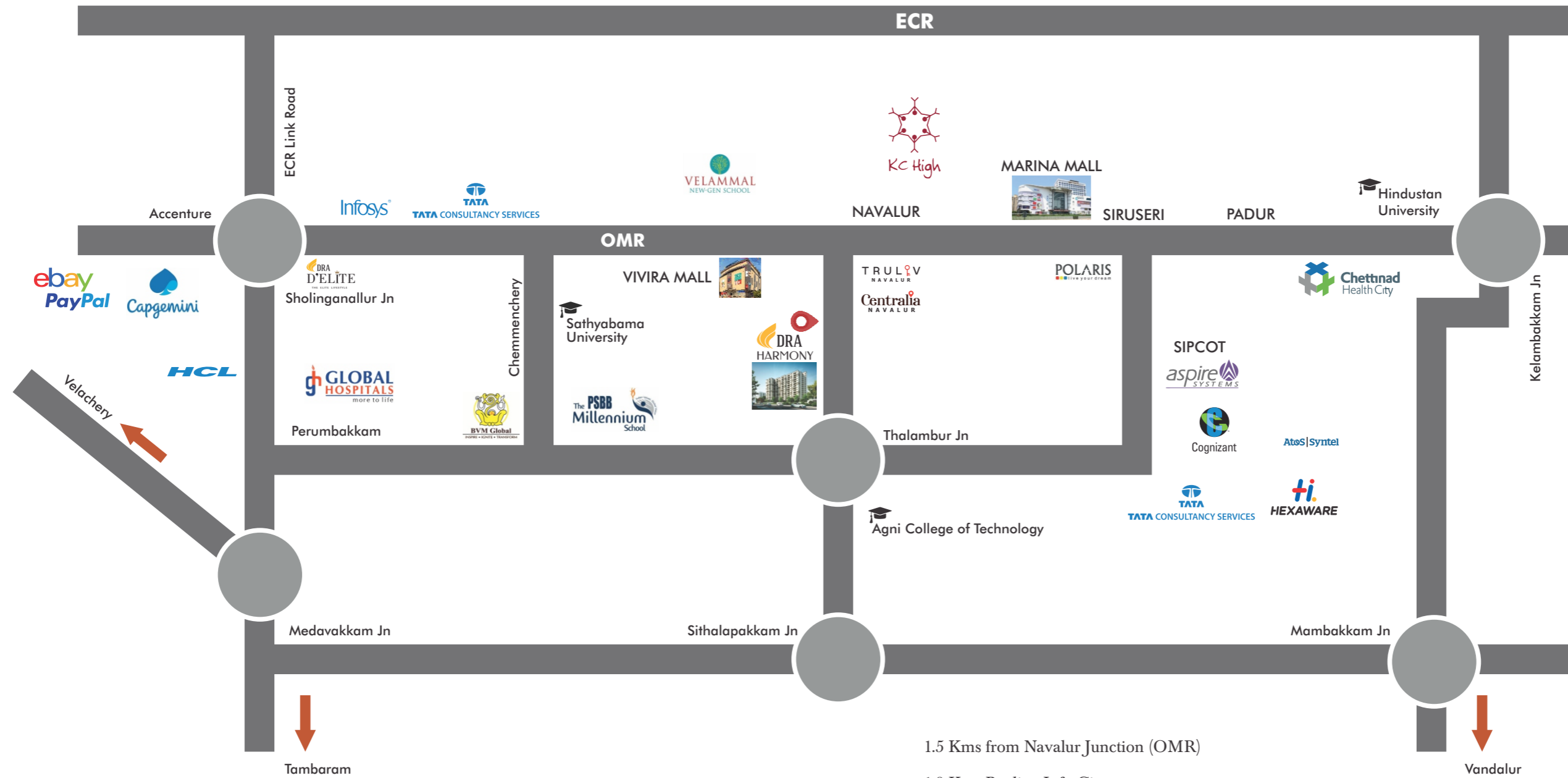

- 1.5 Kms from Navalur Junction (OMR)
- 1.9 Kms Bayline Info City
- 2.0 Kms from Vivira Mall
- 2.1 Kms from Pacifica Tech Park
- 2.6 Kms from Marina Mall
- 3.1 Kms before SIPCOT (Siruseri)
- 1.5 Kms from Upcoming Metro Station & Elevated Highway

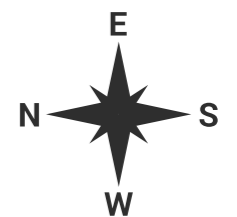



Land Extent	:	1.40 Acres
Total Units	:	143 Units
Number of Block	:	1 No.
No. of Floors	:	Stilt + Upper Stilt + 13 Floors
No. of Units / Floor	:	11
Apartment Types & Sizes	:	2 BHK+2T : 1039 Sq.ft. - 1101 Sq.ft. 3 BHK+2T : 1252 Sq.ft. - 1418 Sq.ft. 3 BHK+3T : 1489 Sq.ft. & 1494 Sq.ft.



# SITE CUM STILT FLOOR PLAN

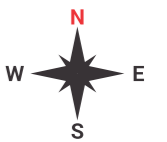



# UPPER STILT FLOOR PLAN

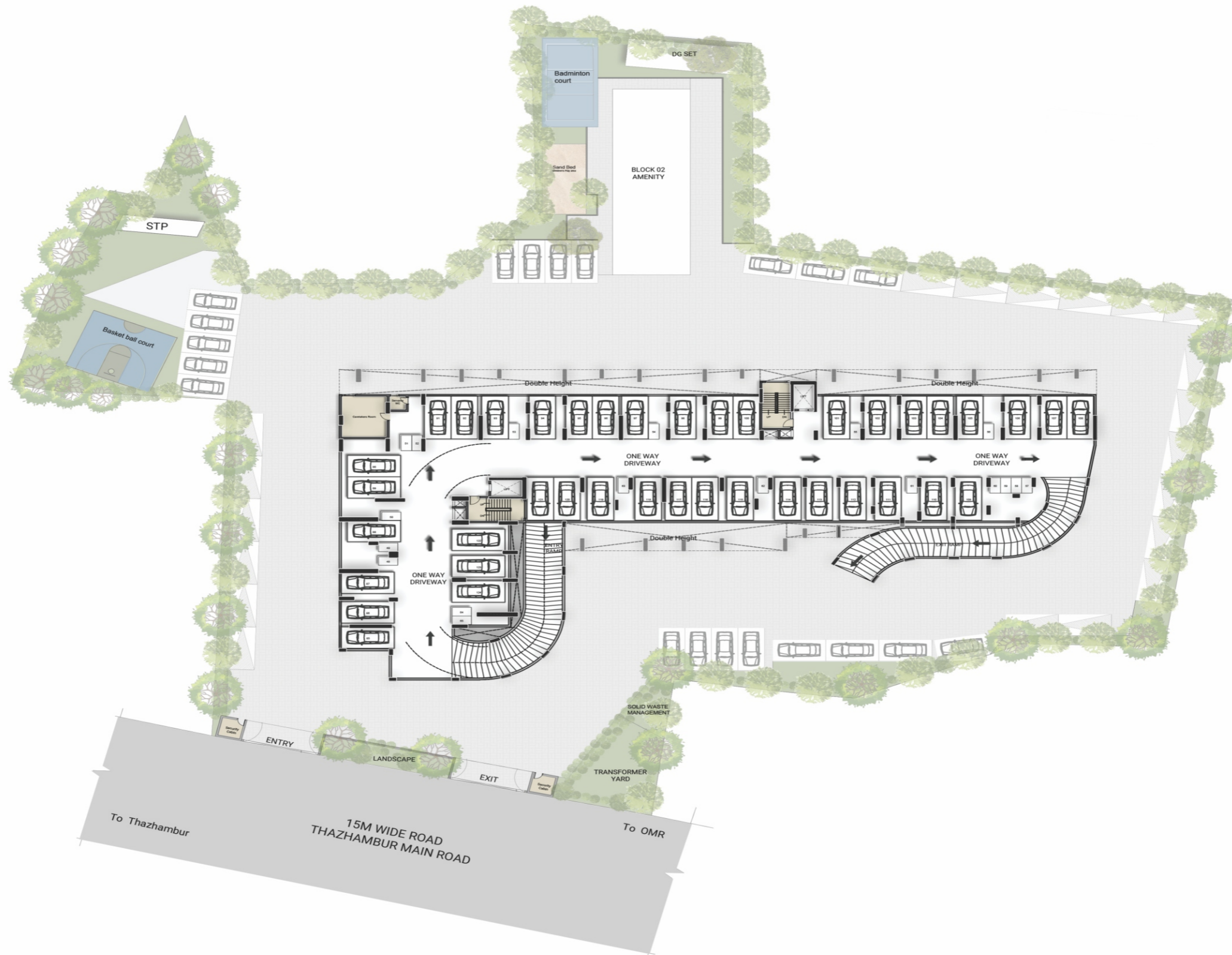



# CLUB HOUSE PLAN - FIRST FLOOR

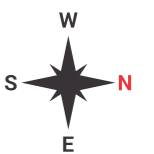



# CLUB HOUSE PLAN - GROUND FLOOR

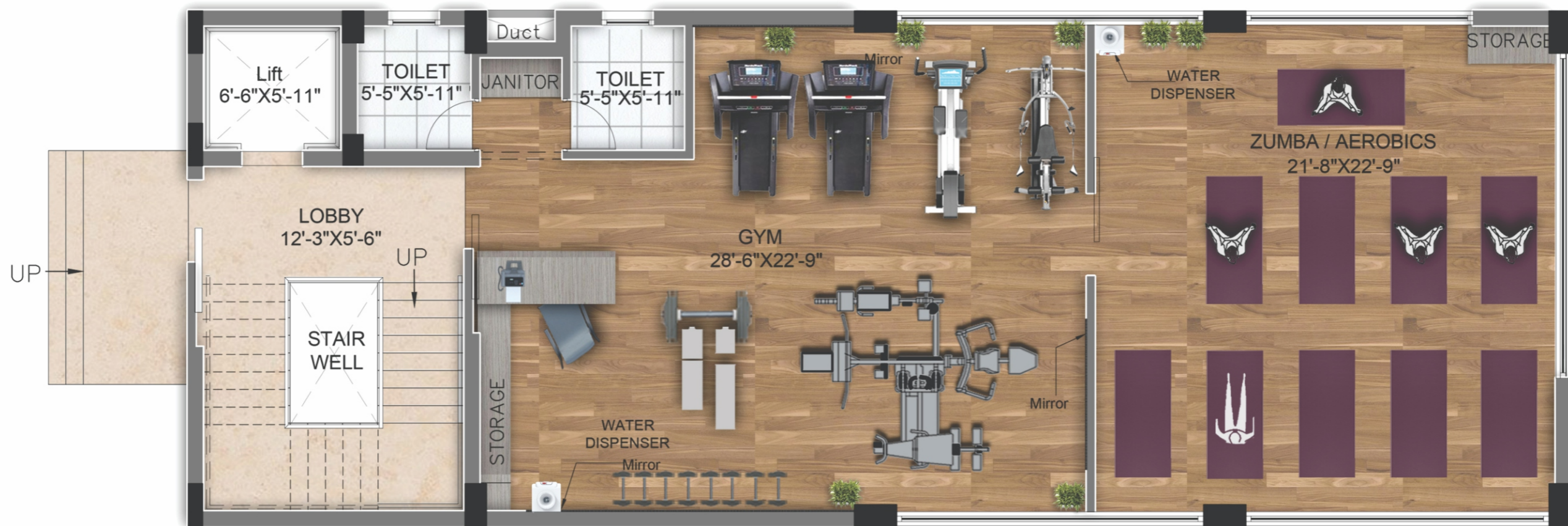



# TYPICAL FLOOR PLAN - 2<sup>nd</sup> to 13<sup>th</sup> FLOOR

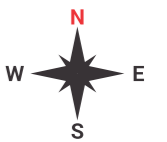



# INDIVIDUAL UNIT PLAN (2 BHK+2T - 1039 Sq.ft.)

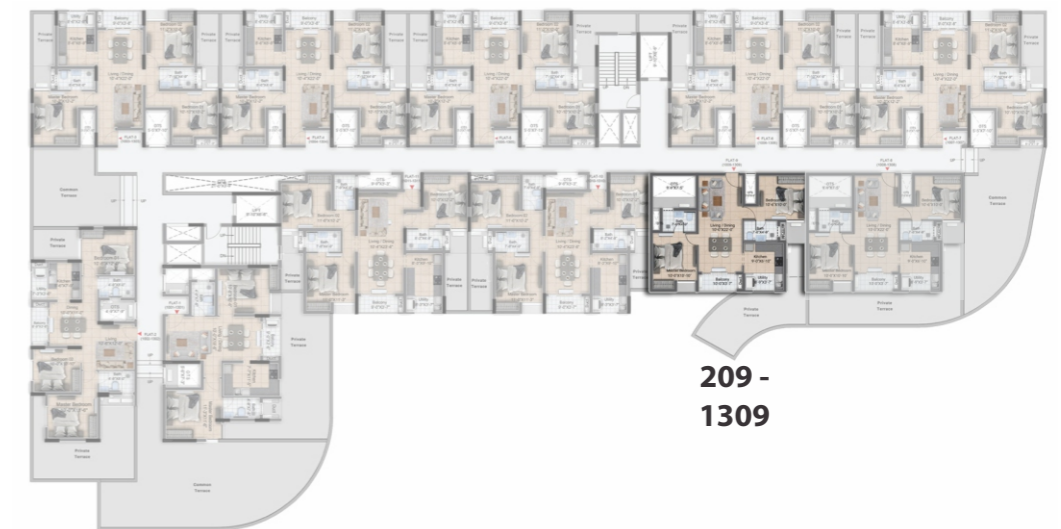

**UNIT PLAN : 2BHK+2T - North Facing**

Saleable Area - 1039 Sq.ft. | RERA Carpet Area - 648 Sq.ft. | UDS Area : 349 Sq.ft. | Unit Nos. : 209 - 1309

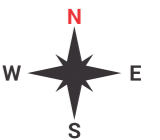



# ISOMETRIC VIEW (2 BHK+2T - 1039 Sq.ft.)

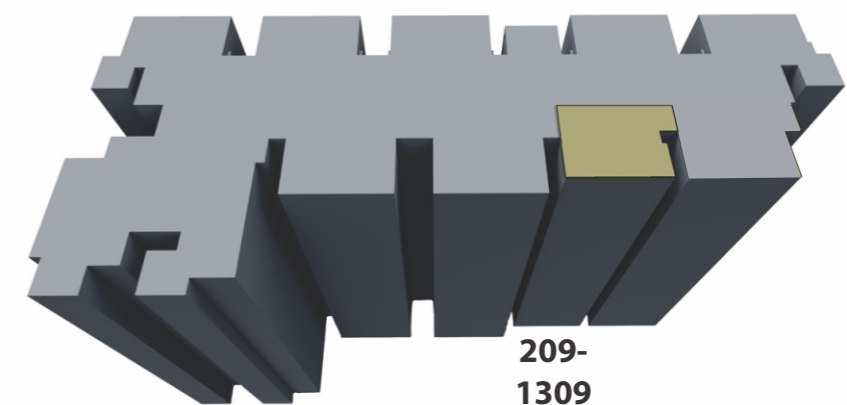

## UNIT PLAN : 2BHK+2T - North Facing

Saleable Area - 1039 Sq.ft. | RERA Carpet Area - 648 Sq.ft. | UDS Area : 349 Sq.ft. | Unit Nos. : 209 - 1309

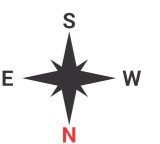



# INDIVIDUAL UNIT PLAN (2 BHK+2T - 1045 Sq.ft.)

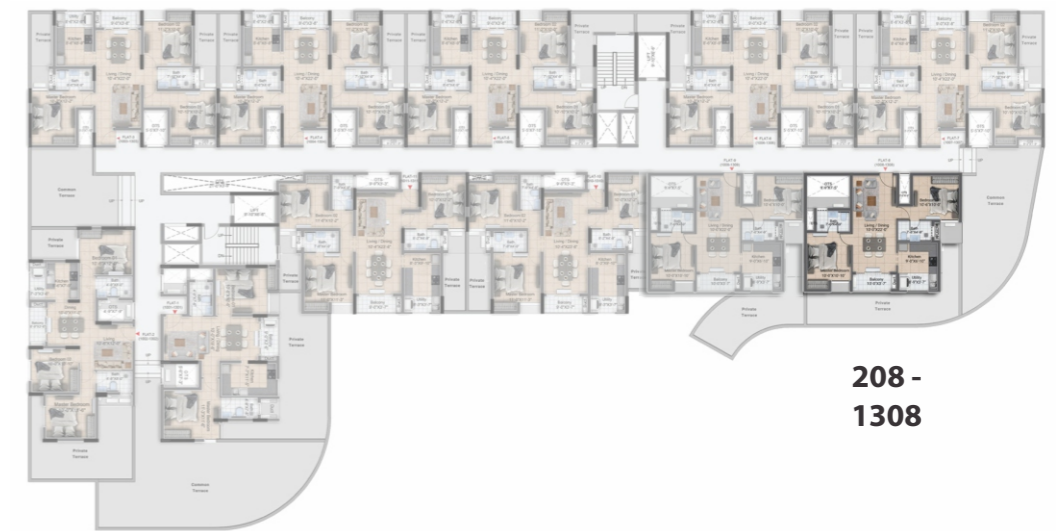

**208 -  
1308**

**UNIT PLAN : 2BHK+2T - North Facing**

Saleable Area - 1045 Sq.ft. | RERA Carpet Area - 648 Sq.ft. | UDS Area : 351 Sq.ft. | Unit Nos. : 208 - 1308

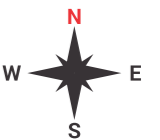



# ISOMETRIC VIEW (2 BHK+2T - 1045 Sq.ft.)



## UNIT PLAN : 2BHK+2T - North Facing

Saleable Area - 1045 Sq.ft. | RERA Carpet Area - 648 Sq.ft. | UDS Area : 351 Sq.ft. | Unit Nos. : 208 - 1308





# INDIVIDUAL UNIT PLAN (2 BHK+2T - 1101 Sq.ft.)

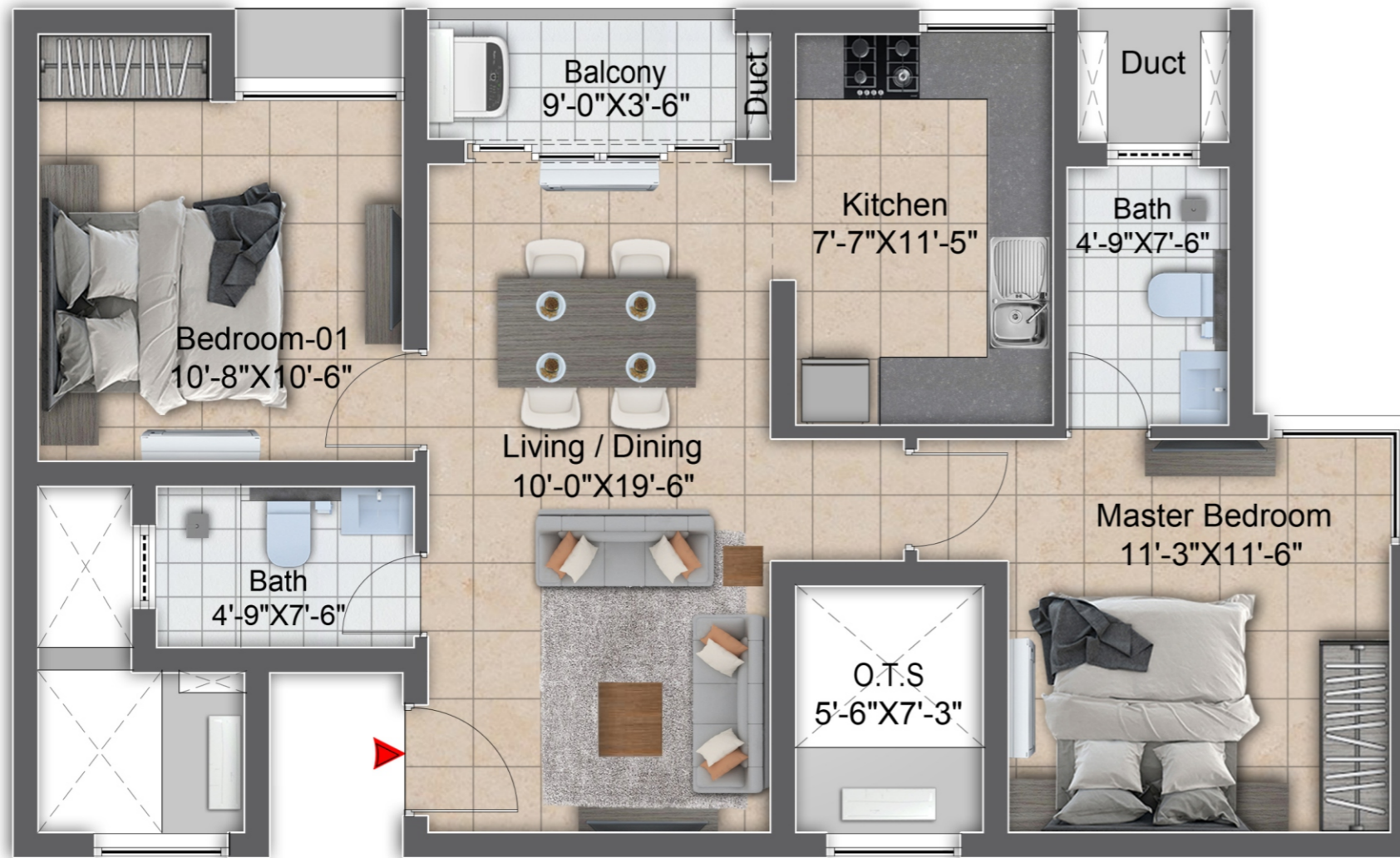

**UNIT PLAN : 2BHK+2T - North Facing**

Saleable Area - 1101 Sq.ft. | RERA Carpet Area - 659 Sq.ft. | UDS Area : 370 Sq.ft. | Unit Nos. : 201 - 1301





# ISOMETRIC VIEW (2 BHK+2T - 1101 Sq.ft.)

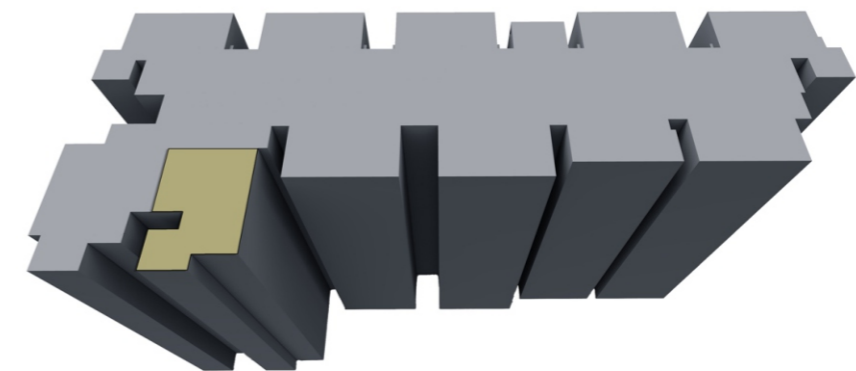

201 -  
1301

## UNIT PLAN : 2BHK+2T - North Facing

Saleable Area - 1101 Sq.ft. | RERA Carpet Area - 659 Sq.ft. | UDS Area : 370 Sq.ft. | Unit Nos. : 201 - 1301

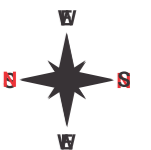



# INDIVIDUAL UNIT PLAN (3 BHK+2T - 1252 Sq.ft.)

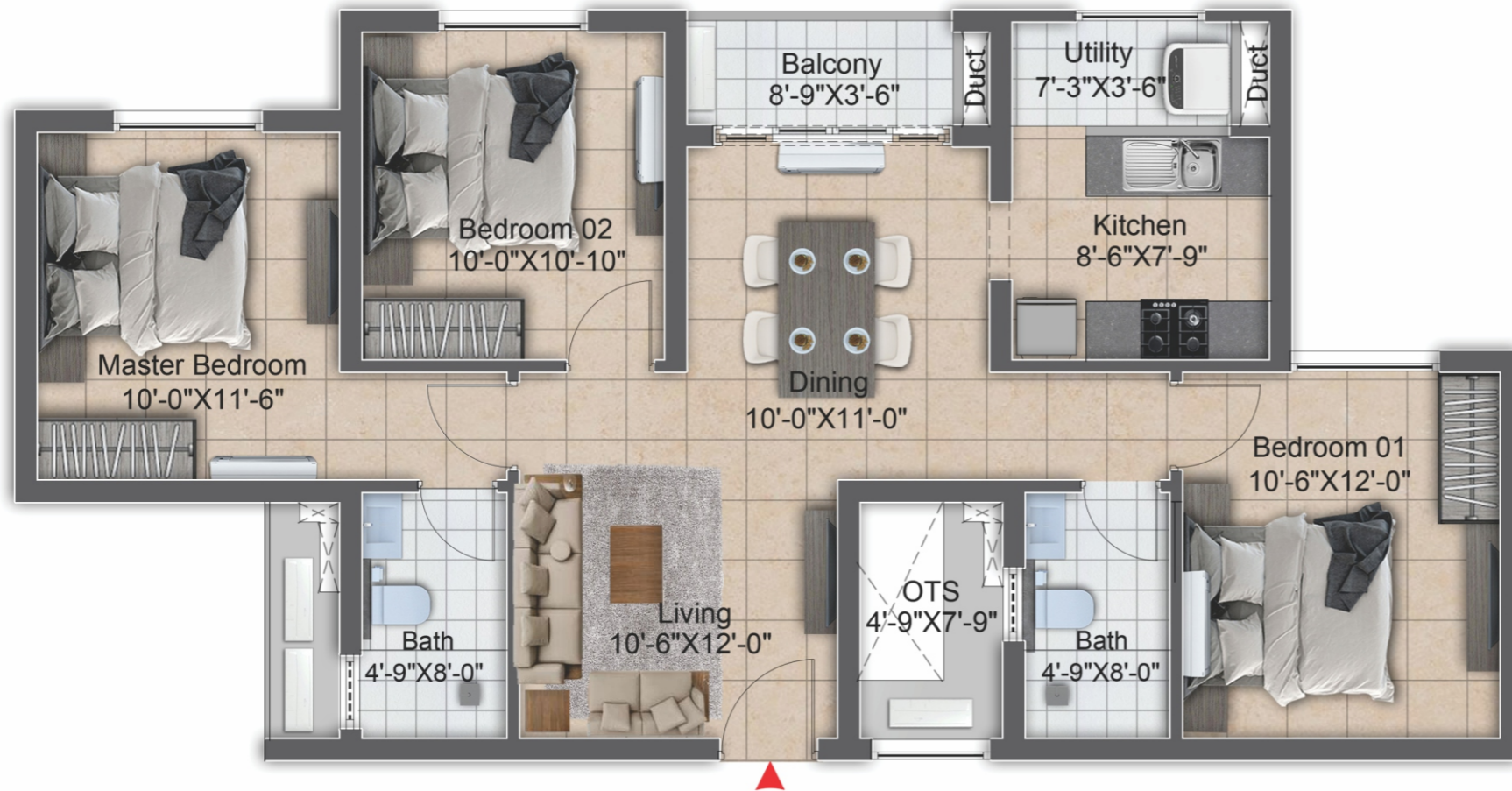

**UNIT PLAN : 3BHK+2T - East Facing**

Saleable Area - 1252 Sq.ft. | RERA Carpet Area - 820 Sq.ft. | UDS Area : 420 Sq.ft. | Unit Nos. : 202 - 1302





# ISOMETRIC VIEW (3 BHK+2T - 1252 Sq.ft.)

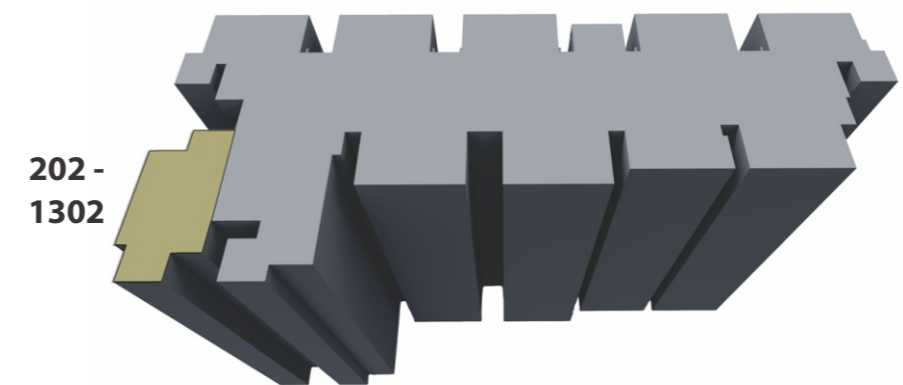

## UNIT PLAN : 3BHK+2T - East Facing

Saleable Area - 1252 Sq.ft. | RERA Carpet Area - 820 Sq.ft. | UDS Area : 420 Sq.ft. | Unit Nos. : 202 - 1302





# INDIVIDUAL UNIT PLAN (3 BHK+2T - 1409 Sq.ft.)



**UNIT PLAN : 3BHK+2T - East Facing**

Saleable Area - 1409 Sq.ft. | RERA Carpet Area - 896 Sq.ft. | UDS Area : 473 Sq.ft. | Unit Nos. : 204 - 1304





# ISOMETRIC VIEW (3 BHK+2T - 1409 Sq.ft.)

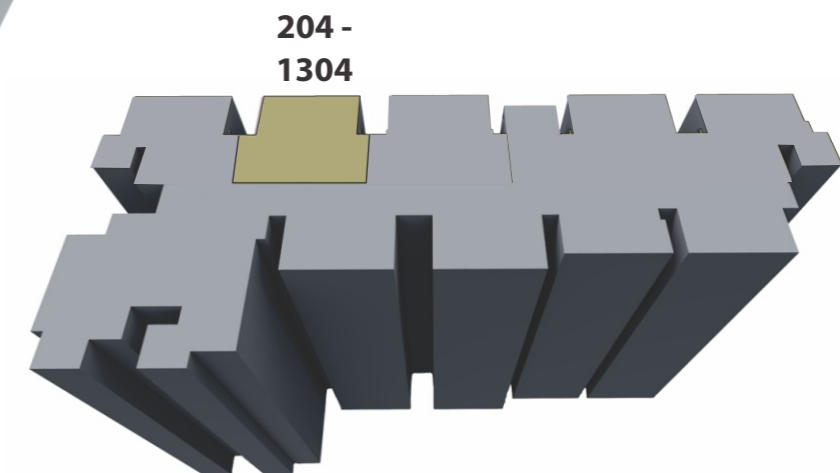

## UNIT PLAN : 3BHK+2T - East Facing

Saleable Area - 1409 Sq.ft. | RERA Carpet Area - 896 Sq.ft. | UDS Area : 473 Sq.ft. | Unit Nos. : 204 - 1304





# INDIVIDUAL UNIT PLAN (3 BHK+2T - 1416 Sq.ft.)

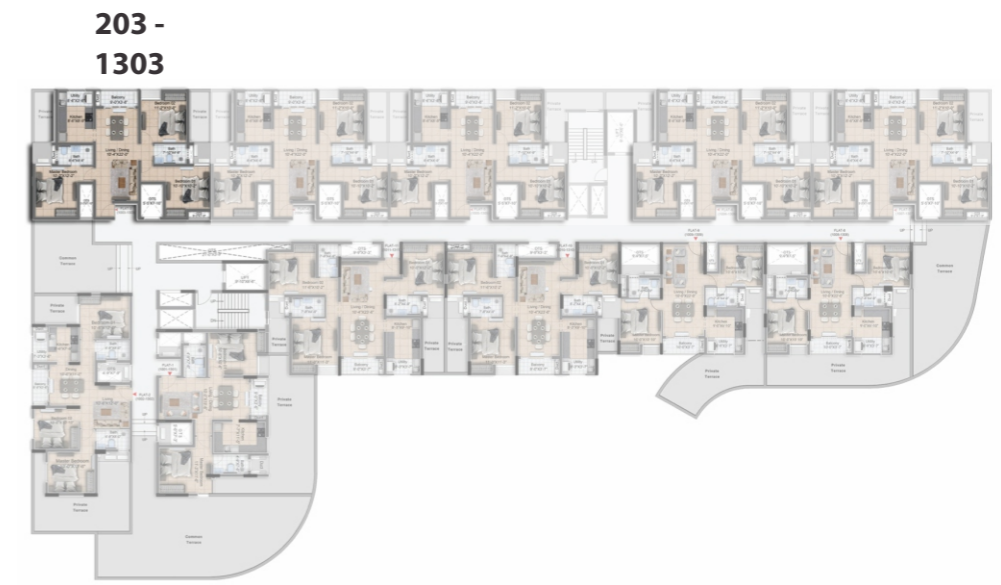

**UNIT PLAN : 3BHK+2T - East Facing**

Saleable Area - 1416 Sq.ft. | RERA Carpet Area - 896 Sq.ft. | UDS Area : 476 Sq.ft. | Unit Nos. : 203 - 1303





# ISOMETRIC VIEW (3 BHK+2T - 1416 Sq.ft.)

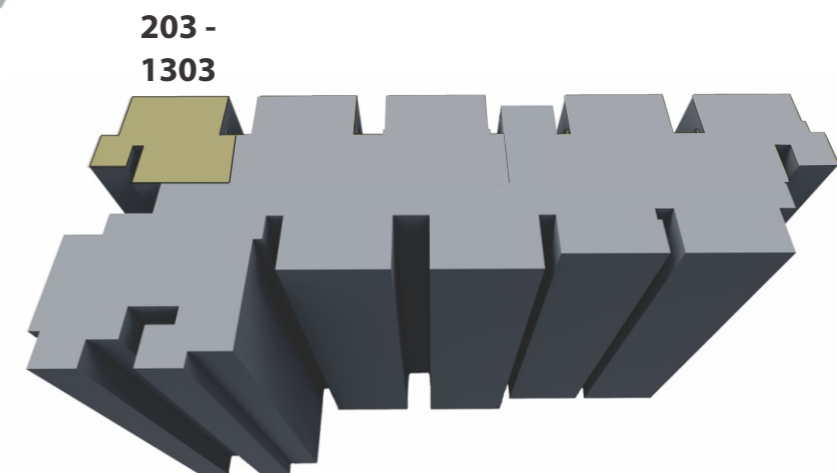

## UNIT PLAN : 3BHK+2T - East Facing

Saleable Area - 1416 Sq.ft. | RERA Carpet Area - 896 Sq.ft. | UDS Area : 476 Sq.ft. | Unit Nos. : 203 - 1303





# INDIVIDUAL UNIT PLAN (3 BHK+2T - 1416 Sq.ft.)

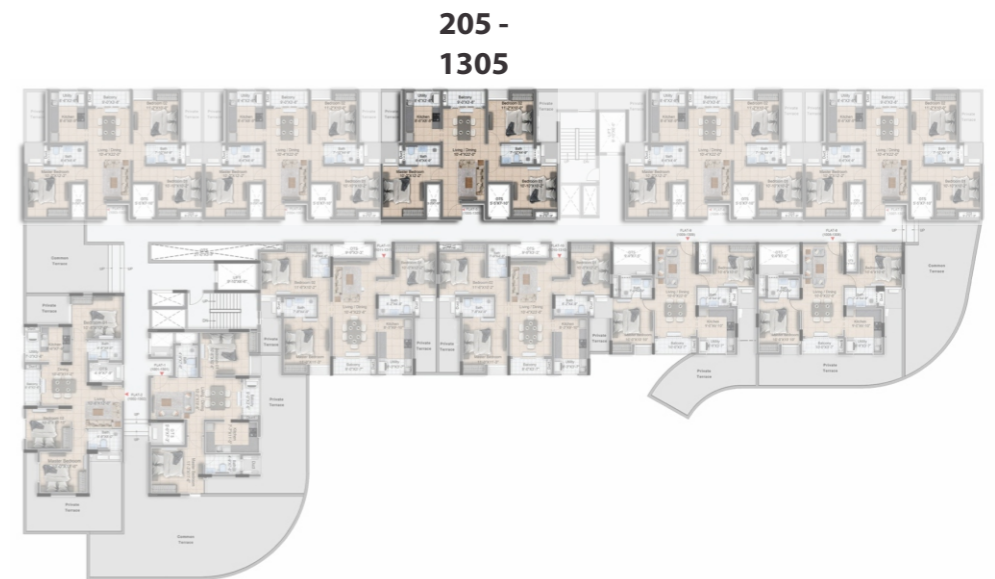

**UNIT PLAN : 3BHK+2T - East Facing**

Saleable Area - 1416 Sq.ft. | RERA Carpet Area - 896 Sq.ft. | UDS Area : 476 Sq.ft. | Unit Nos. : 205 - 1305





# ISOMETRIC VIEW (3 BHK+2T - 1416 Sq.ft.)

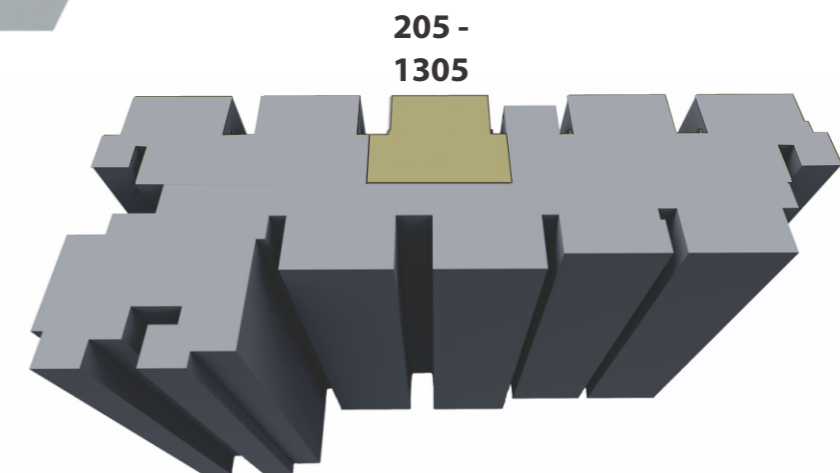

## UNIT PLAN : 3BHK+2T - East Facing

Saleable Area - 1416 Sq.ft. | RERA Carpet Area - 896 Sq.ft. | UDS Area : 476 Sq.ft. | Unit Nos. : 205 - 1305





# INDIVIDUAL UNIT PLAN (3 BHK+2T - 1416 Sq.ft.)

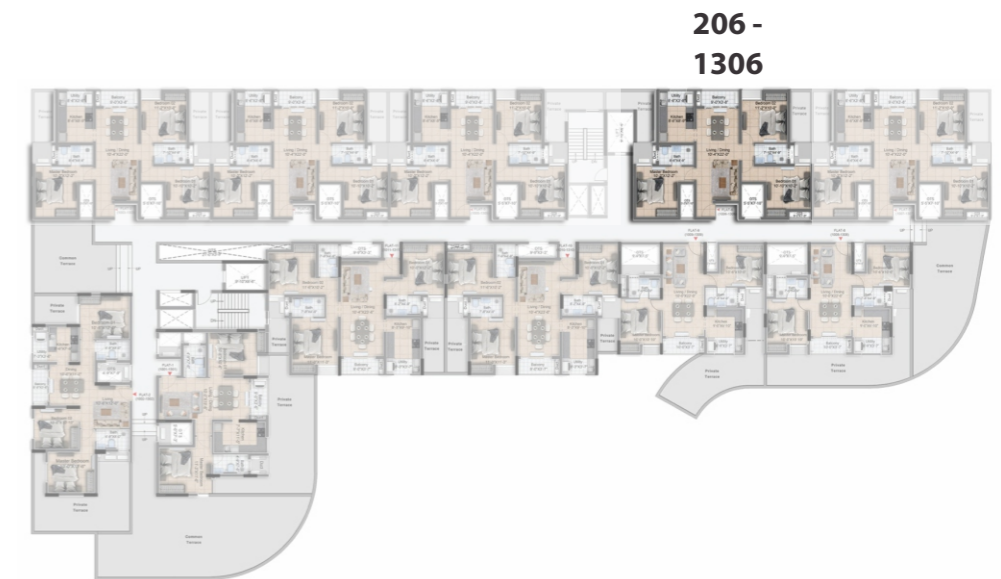

**UNIT PLAN : 3BHK+2T - East Facing**

Saleable Area - 1416 Sq.ft. | RERA Carpet Area - 896 Sq.ft. | UDS Area : 476 Sq.ft. | Unit Nos. : 206 - 1306





# ISOMETRIC VIEW (3 BHK+2T - 1416 Sq.ft.)

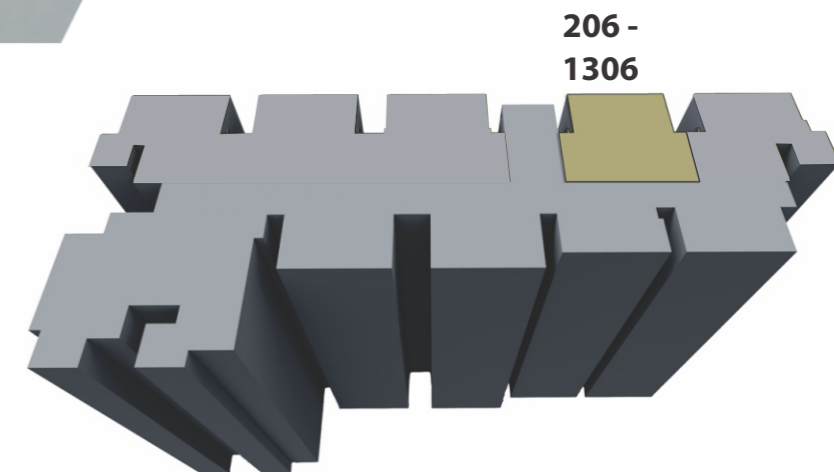

## UNIT PLAN : 3BHK+2T - East Facing

Saleable Area - 1416 Sq.ft. | RERA Carpet Area - 896 Sq.ft. | UDS Area : 476 Sq.ft. | Unit Nos. : 206 - 1306





# INDIVIDUAL UNIT PLAN (3 BHK+2T - 1418 Sq.ft.)

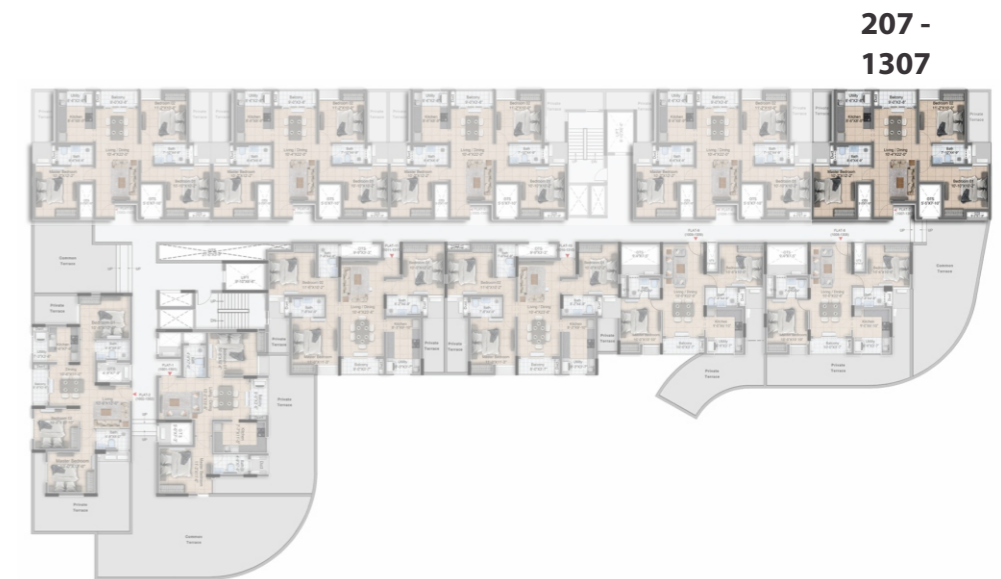

**UNIT PLAN : 3BHK+2T - East Facing**

Saleable Area - 1418 Sq.ft. | RERA Carpet Area - 896 Sq.ft. | UDS Area : 476 Sq.ft. | Unit Nos. : 207 - 1307





# ISOMETRIC VIEW (3 BHK+2T - 1418 Sq.ft.)

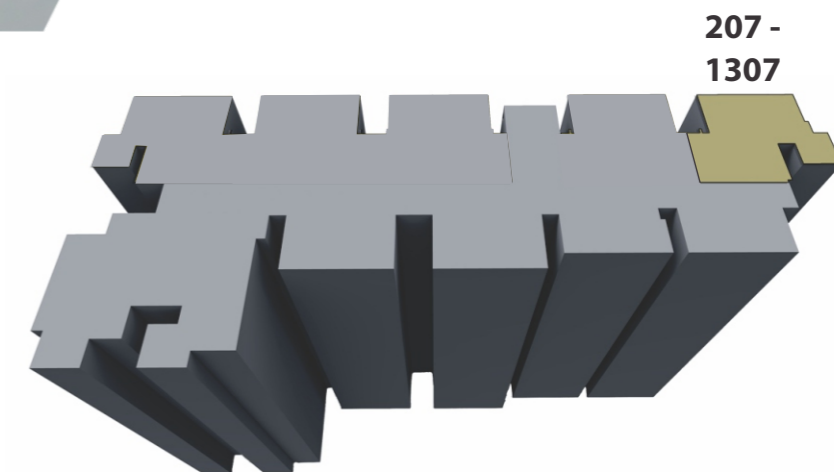

## UNIT PLAN : 3BHK+2T - East Facing

Saleable Area - 1418 Sq.ft. | RERA Carpet Area - 896 Sq.ft. | UDS Area : 476 Sq.ft. | Unit Nos. : 207 - 1307





# INDIVIDUAL UNIT PLAN (3 BHK+3T - 1489 Sq.ft.)

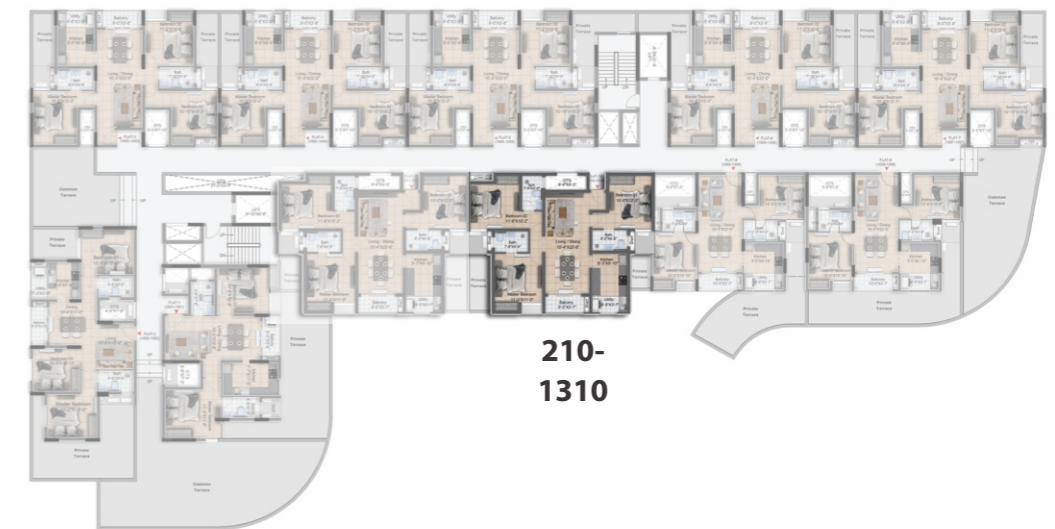
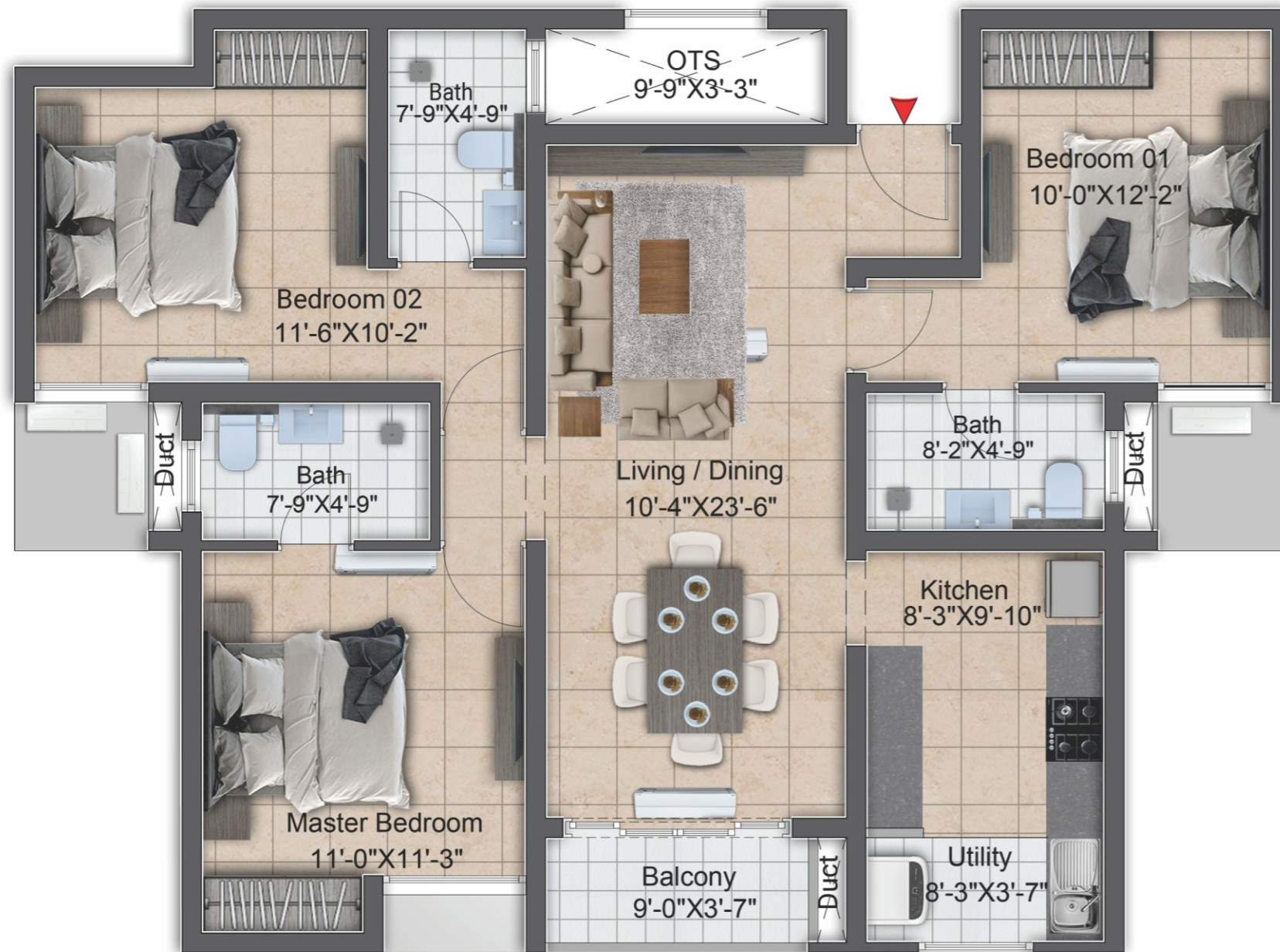

**UNIT PLAN : 3 BHK+3T - North Facing**

Saleable Area - 1489 Sq.ft. | RERA Carpet Area - 981 Sq.ft. | UDS Area : 500 Sq.ft. | Unit Nos. : 210 - 1310

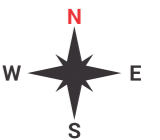



# ISOMETRIC VIEW (3 BHK+3T - 1489 Sq.ft.)

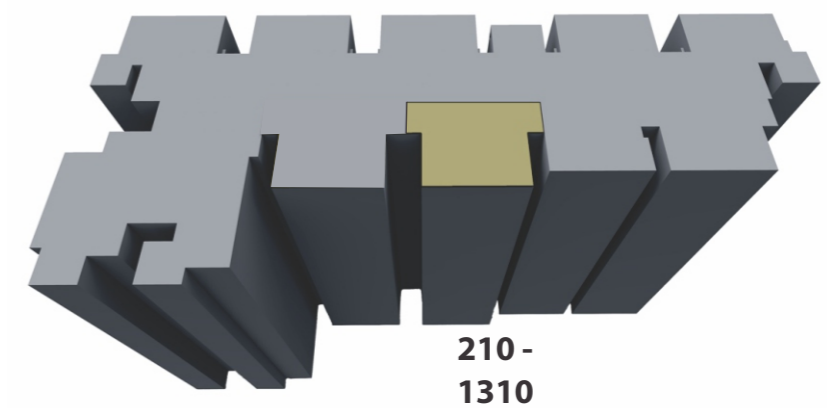

## UNIT PLAN : 3 BHK+3T - North Facing

Saleable Area - 1489 Sq.ft. | RERA Carpet Area - 981 Sq.ft. | UDS Area : 500 Sq.ft. | Unit Nos. : 210 - 1310



# INDIVIDUAL UNIT PLAN (3 BHK+3T - 1494 Sq.ft.)

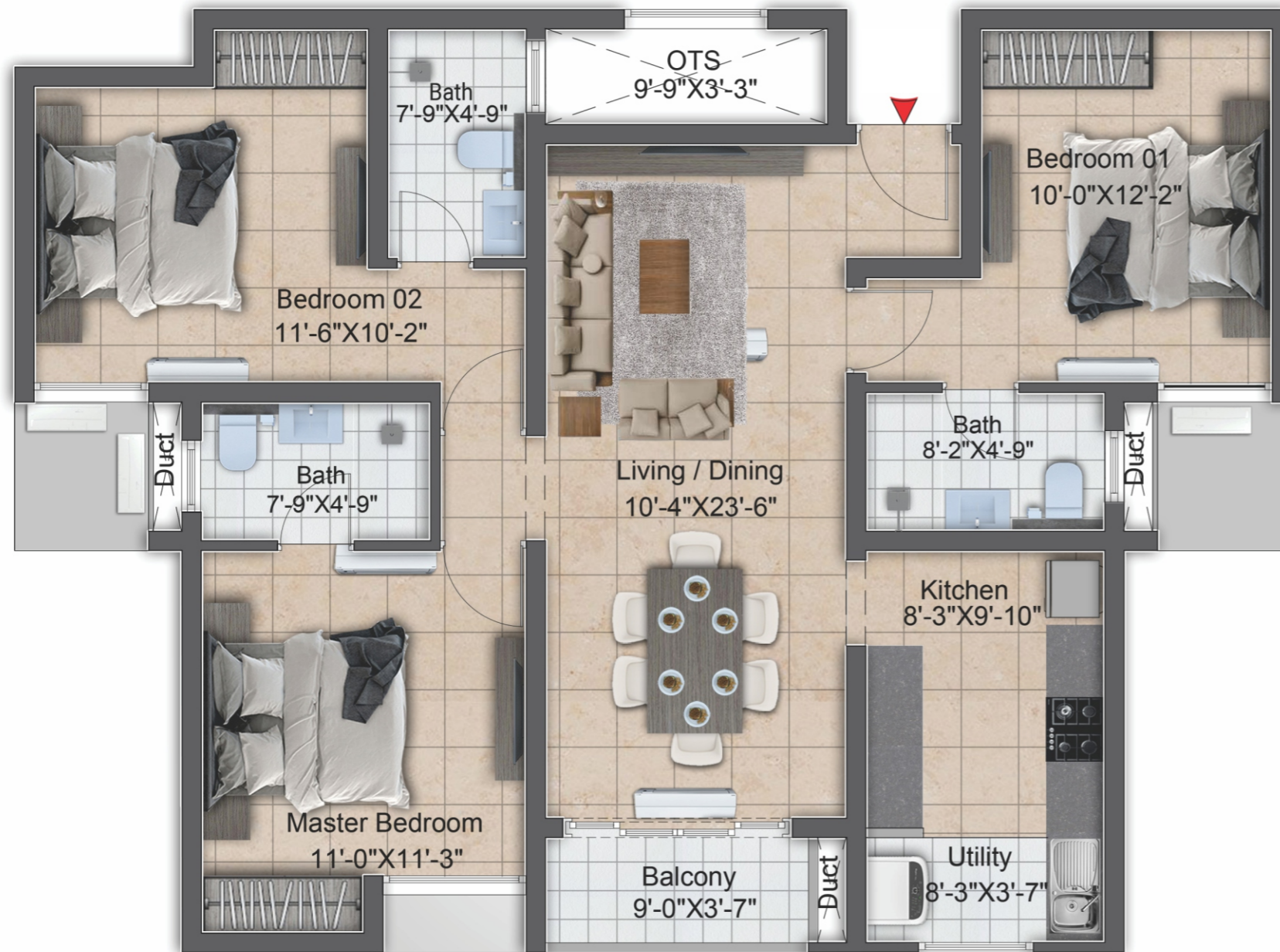

**UNIT PLAN : 3 BHK+3T - North Facing**

Saleable Area - 1494 Sq.ft. | RERA Carpet Area - 981 Sq.ft. | UDS Area : 502 Sq.ft. | Unit Nos. : 211 - 1311

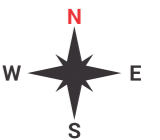



# ISOMETRIC VIEW (3 BHK+3T - 1494 Sq.ft.)

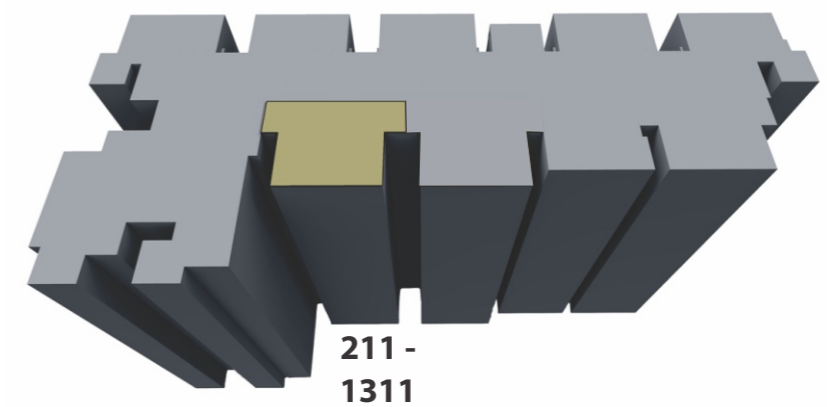

## UNIT PLAN : 3 BHK+3T - North Facing

Saleable Area - 1494 Sq.ft. | RERA Carpet Area - 981 Sq.ft. | UDS Area : 502 Sq.ft. | Unit Nos. : 211 - 1311



## 1. STRUCTURE

- Structural System : RCC framed structure designed for seismic compliance (Zone-III).
- Masonry : AAC block masonry wall
- Pest Control : Anti-termite treatments wherever applicable during the construction stage.

## 2. FLOOR FINISH WITH SKIRTING

- Living, dining : 600mm x 600mm vitrified tile flooring and skirting
- Bedrooms& kitchen : 600mm x 600mm vitrified tile flooring and skirting
- Bathrooms : 300mm x 300mm anti-skid ceramic tile flooring
- Balcony : 300mm x 300mm anti-skid ceramic tile flooring
- Utility / service area : 300mm x 300mm anti-skid ceramic tile flooring

## 3. WALL FINISHES

- Internal walls : Two coats of acrylic emulsion over one coat primer and two coats of wall putty
- Ceiling : Two coats of acrylic emulsion over one coat primer and two coats of wall putty
- Exterior walls : Plaster finish with weather proof texture paint or weather proof emulsion paint as decided by the architect
- Bathrooms : 300mm x 450mm Glazed ceramic wall tiles up to 7'-0" height
- Kitchen : Glazed ceramic wall tile 2'-0" above the kitchen counter
- Utility : Glazed ceramic wall tile up to 3'-0"

## 4. KITCHEN&UTILITY / SERVICE AREA

- Kitchen platform : Platform with granite counter slab 2'-0" wide at height of 800mm from the finished floor level.
- Kitchen sink : Stainless steel single bowl sink without drain board and sink faucet of Hindware / Parryware or equivalent
- Electrical point : Provision for exhaust & water purifier
- Utility area : Provision for washing machine



# SPECIFICATIONS

## 5. BATHROOMS

- Sanitary fixture : Wall mounted European Water Closet (EWC) of Hindware / Parryware or equivalent will be provided with concealed cistern.
- Cp fitting : Health faucet, pillar cock, wall mixer, overhead shower Hindware / Parryware or equivalent
- Drain : SS square designed gratings will be provided
- False ceiling : Grid type false ceiling will be provided above 7'-0" height(easy maintenance of plumbing lines & geysers)

## 6. JOINERY

- Main doors : Pre-engineered veneer finish flush door with ironmongery like door lock, tower bolt, door viewer, magnetic catcher in SS finish will be provided.
- Bedroom doors : Pre-engineered laminate finish flush door with ironmongery like door lock, tower bolt, magnetic catcher in SS finish will be provided.
- Bathroom doors : Pre-engineered laminate finish flush door with ironmongery like thumb turn lock and a latch will be provided

## 7. WINDOWS

- Windows : UPVC sliding windows with bug mesh will be provided inside the apartments (except openable windows & bug mesh protects you from the menace of mosquitoes) - (U)
- French doors : UPVC frame and sliding door with see through glass
- Ventilators : UPVC frame of fixed or adjustable louvered or openable shutter for ODU access
- MS Grill : MS safety grills will be provided all the sliding windows inside the apartment

## 8. HANDRAIL

- Balcony handrails : MS handrail will be provided as per architect design

## 9. WATERPROOFING

- Water proofing : Water proofing will be done the water retain area like lift pit, toilet, balcony & utility / service area, UG sump, STP & OHT

## 10. ELECTRICAL

- Power Supply : 3 Phase connection for each apartment
- Power back-up : 350 watts for 2 BHK & 500 watts for 3 BHK through Automatic Changeover Current & Limiter (ACCL). (Instead of pre-designed use of electrical light points during power cut flexibility to use the lighting circuit of choice within the allotted power capacity).



Safety device	:	RCCB safety device will be provided for each apartment (protection against voltage fluctuations, earth fault as well as any leakage current)
Switches & sockets	:	Modular Switches and sockets will be of Anchor Roma / L & T or equivalent
Wires	:	Fire Retardant Low Smoke (FRLS) copper wire of a quality ISI brand
TV	:	Provision for TV in living and master bedroom with pre-wired co-axial cable for DTH easy connectivity
Data	:	Provision for fibre optical cabling in living
Air-conditioner	:	Split air-conditioner provision will be provided living/dining and all the bedrooms. Pre - installed conduit provided as provision for A/C (Easy for fixing your air-conditioner without calling technicians to drill the walls)
Exhaust fan	:	Exhaust fan provision for all the toilet
Geyser	:	Geyser provision for all the toilets

#### 11. PLUMBING

Water supply	:	Hydro pneumatic Pressure System (Provides water at constant pressure in all apartment irrespective of the floor vis-à-vis traditional overhead tank) - (U)
Internal	:	All internal plumbing line are CPVC
External	:	All external plumbing lines are UPVC / PVC pipes
Drainage	:	All drainage plumbing lines are PVC pipes

#### 12. COMMON FEATURES

Power back-up	:	100% power back-up for common areas
Lift	:	2 Elevators of 13 passenger stretcher lift
Lift fascia	:	Granite or panel cladding will be provided
Lobby & corridor	:	Ground floor lobby finished with granite flooring with gypsum false ceiling. All the corridors will be finished with tile flooring with matching skirting. Painting will be two coats of acrylic emulsion over one coat primer
Staircase	:	Rustic tile flooring and painting will two coats of acrylic emulsion over one coat primer
Staircase handrail	:	MS handrail with enamel paint for all the floors
Stilt & Upper Stilt	:	Granolith cement flooring with car park numbering and painting will be two coats of acrylic emulsion over one coat primer



Terrace floor	:	Weathering course with pressed clay tile finishing
Driveway	:	Well defined driveway with interlocking paver block laid all-round the building, demarcation of driveway, convex mirror, driveway lighting, speed breakers for safe turning in driveway
Rain water harvest	:	Adequate rain water harvesting pit will be provided at site
STP	:	Centralized sewage treatment plant will be provided
Safety	:	CCTV surveillance cameras will be provided at entry and exit, stilt lobby & driveway
Security	:	Security cabin will be provided at the entrance
Compound wall	:	Building perimeter fenced by the compound wall with grand entry gates for a height as per architect / landscape design
Landscape	:	Adequate landscape will be provided as per the landscaping consultant
Signages	:	Apartment owners name board will be provided in the stilt floor

### 13. AMENITIES

Gym	:	Well-equipped gymnasium
Zumba & Aerobic	:	Space for Zumba and Aerobic
Indoor games	:	Indoor games like table tennis, carrom, chess, foosball, scrabble, Board games
Multipurpose hall	:	Multipurpose hall with furnitures
Kids Play area	:	Kids play equipment like Slider, Merry GO Round, Seesaw & Spring Rider
Badminton Court	:	Outdoor badminton court will be provided
Basket Ball Hoop	:	Half-court basketball hook will be provided
Senior Citizen Area	:	Relaxation place for Senior Citizen
Landscape	:	Adequate landscaping will be provided
Association room	:	Association room will be provided
Common Toilet	:	Toilet at stilt floor for drivers / domestic help
Solar panel	:	Solar panels will be provided at terrace for common service meter
EV charging	:	Two-wheeler electric charging point will be provided at designated location in the stilt floor level



## PARTNERS FOR DEVELOPMENT

<u>Architect</u> Kharche & Associates	<u>Structural</u> Designage Consulting Structural Engineers	<u>MEP</u> Optimal MEP Consultants
---	---	--

---

## HOME LOAN PARTNERS



---

Member







Site Office: DRA HARMONY, Navalur - Thalambur Main Road, Navalur, Chennai - 600 130.  
Corporate Office: #480, 1st Floor, Khivraj Complex, Anna Salai, Nandanam, Chennai, Tamil Nadu - 600 035.

---

[www.drahomes.in](http://www.drahomes.in)

---

Disclaimer : This brochure does not constitute a legal offering. Elevation, specifications, plans, furniture & fittings and other offerings are subject to change without notice